



SHURE

PREMIUM AUDIO FOR AV CONFERENCING

PREMIUM AUDIO FOR AV CONFERENCING

MICROFLEX® ADVANCE™

©2020-2022 Shure Incorporated.
SHURE and the SHURE logotype are registered trademarks of Shure Incorporated or
Shure Acquisition Holdings, Inc. For additional information, see shure.com/trademarks.

WHY CHOOSE SHURE?

Shure is uniquely positioned as a leading audio equipment manufacturer serving corporate, education, government, broadcast/TV/film, and independent content creators. By choosing Shure, you will enjoy a range of benefits:

- + Nearly 100-year heritage of technical leadership in high-quality audio, acoustics, wireless, DSP, software, and audio networking technologies.
- + Broad product selection that can be customized to meet the needs of any user, space, or application – from simple to complex, small to large.
- + Compatibility and certification with leading software and hardware collaboration platforms; compliance with international regulatory standards.
- + Award-winning global support infrastructure.



AV conferencing has become an essential tool for communication. But it's easy to forget that the most important content is often carried by the audio, not the video. If the video fails, the meeting can go on; but if the audio fails, the meeting is over.

Poor audio inhibits productivity and fatigues meeting participants. Superior audio can transform your meetings from an exhausting struggle into a forum that supports creativity and productive teamwork.

ADVANTAGES

ADVANTAGES

MXA920 CEILING ARRAY MICROPHONE +



SUPERIOR PERFORMANCE. UNMATCHED AESTHETICS.

Since their introduction, Microflex® Advance™ Networked Array Microphones have been the premier choice for audio in the most challenging environments. They capture voice naturally, fit harmoniously with the room's appearance, and make it effortless to connect people for the world's leading enterprises. The industry-leading Microflex® Advance™ microphones have revolutionized versatile and elegant AV conferencing solutions that discreetly and precisely capture every word.



+ MXA310 TABLE ARRAY MICROPHONE



+ MXA710 LINEAR ARRAY MICROPHONE

ADVANTAGES

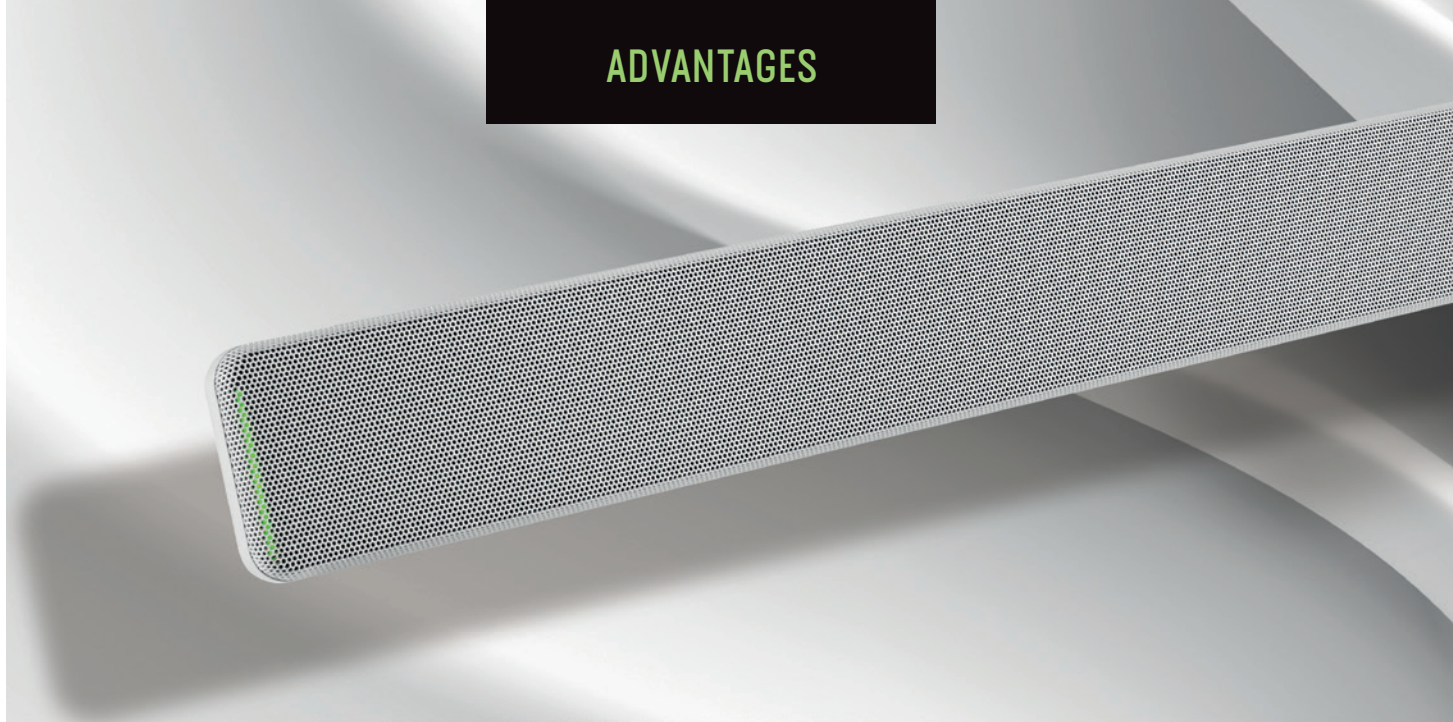

YOUR MXA ADVANTAGE

ARCHITECT / INTERIOR DESIGNER

Microflex Advance enables architects and interior designers to create visually stunning workspaces without sacrificing sound quality.

USERS

Microflex Advance allows users to be more productive and creative. It enhances communication by allowing everyone to hear and be heard clearly, without distracting noise and echo.

C-LEVEL EXECUTIVES

Teams work more effectively when communication is natural and effortless. Microflex Advance makes poor audio a thing of the past.

SYSTEM INTEGRATOR

The complete Shure networked systems ecosystem, from microphone to DSP to loudspeaker, enables your teams to deliver great AV solutions quickly and efficiently.

IT MANAGER / ADMIN

Microflex Advance integrates into your existing IT infrastructure, without affecting network performance. Scalable to any size, it makes AV/IT support less time consuming.

CFO / FINANCE DIRECTOR

Microflex Advance is a cost-effective audio solution that can be deployed across your organization, providing a consistent user experience backed by industry-leading support and reliability.

ADVANTAGES

MXA ARRAY TECHNOLOGY

Microflex Advance networked array microphones rely on a suite of advanced technologies to deliver accurate audio in any environment.

PRECISE COVERAGE

Controlling which sounds are picked up is the foundation of good audio. The MXA920 features Automatic Coverage™ technology that captures talkers in defined areas automatically. The MXA710 and MXA310 use Steerable Coverage™ technology that allows pickup lobes to be aimed where needed.

POWERFUL DSP

Digital signal processing blends microphone signals into a harmonious mix. The MXA920 and MXA710 feature IntelliMix DSP that controls levels and eliminates noise and echo. The MXA310 includes automatic mixing and per-channel EQ for improved clarity.

FLEXIBLE NETWORKING

Digital audio, power, and control data use Dante or AES67 to coexist on the same network as enterprise applications. Command strings enable integration with third-party systems for camera tracking or room control.



CEILING ARRAY MICROPHONE

Certified for
Microsoft Teams



CEILING ARRAY MICROPHONE



+ MXA920 CEILING ARRAY MICROPHONE

NOW, PRISTINE AUDIO IS AUTOMATIC.

The MXA920 is the premier ceiling array microphone for contemporary meeting spaces. Automatic Coverage™ technology covers up to a 30 x 30 ft (9 x 9 m) area automatically, or place coverage in specific areas for more precise control of audio capture. With next generation array architecture for enhanced directional pickup and more natural speech, the MXA920 is even easier to use and faster to deploy than the MXA910 for AV conferencing, camera tracking, voice lift, or sound reinforcement.

COVERAGE WHERE YOU WANT IT

Automatic Coverage™ technology captures up to a 30 x 30 foot (9 x 9 m) area automatically for great sound out of the box.

You can also place coverage areas in specific locations to limit audio capture to seating areas, a podium, or whiteboard.

SEAMLESS INTEGRATION

Next-generation array architecture delivers more directional pickup at low frequencies for more natural sounding voice.

Onboard IntelliMix DSP with automatic mixing, echo cancellation, noise reduction, and automatic gain control provides a pristine audio mix.

FITS YOUR ROOM DESIGN

Square or round form factors suit your interior design. Choose white, black, or aluminum finish (square available in white only), or paint to match room aesthetics.

Versatile hardware options support in-ceiling, on-ceiling, pole, or wire-rope mounting.

READY FOR ANYTHING

Camera Tracking

Precise talker localization reports the position of simultaneous talkers for more accurate camera tracking.

Voice Lift

Highly directional pickup allows audience members across the room to interact without the need for roving microphones.

Sound Reinforcement

Precise coverage control enables presenters to be amplified without lavalier or gooseneck microphones.

AVAILABLE MODELS

MXA920AL-R	Round Ceiling Array Microphone, 25-inch (aluminum)
MXA920B-R	Round Ceiling Array Microphone, 25-inch (black)
MXA920W-R	Round Ceiling Array Microphone, 25-inch (white)
MXA920W-S	Square Ceiling Array Microphone, 24-inch (white)
MXA920W-S-60CM	Square Ceiling Array Microphone, 60 cm (white)

ACCESSORIES

MXA-MUTE Network Mute Button	Touch-sensitive mute button with programmable switch and LED can control one or multiple MXA microphones or DSP units
A900-PM Pole Mounting Kit	Allows MXA910/920 microphones to be suspended using threaded rod or NPT pole
A900-GM Gripple Mounting Kit	Allows MXA910/920 microphones to be suspended from the ceiling using Gripple fittings
A910-HCM Hard Ceiling Mount	Allows MXA910/MXA920-S to be mounted flush in a hard or drywall ceiling
A910-JB Junction Box Adapter	Allows MXA910/MXA920-S to be connected to wiring in electrical conduit

LINEAR ARRAY MICROPHONE

LINEAR ARRAY MICROPHONE



Certified for
Microsoft Teams



+ MXA710 LINEAR ARRAY MICROPHONE

THE SLIM ALTERNATIVE WHERE SPACE IS LIMITED.

The MXA710's sleek, linear form factor allows for placement virtually anywhere in a meeting space — on a ceiling or wall, around a display, or recessed into the table. Steerable Coverage™ technology allows pickup lobes to be easily adjusted to capture talkers around the room. Available in two lengths and three colors to suit different interior designs and mounting configurations. Onboard IntelliMix DSP provides all the signal processing needed for echo- and noise-free audio.

COVERAGE WHERE YOU WANT IT

Steerable Coverage technology allows you to configure 4 or 8 pickup lobes that can be easily adjusted to capture talkers around the room.

Patent-pending Autofocus™ technology fine-tunes audio pickup in real time, for consistent sound even if participants shift in their seats.

SEAMLESS INTEGRATION

Onboard IntelliMix DSP with automatic mixing, echo cancellation, noise reduction, and automatic gain control provides a pristine audio mix.

Programming-free LED mute sync with popular software codecs when connected to IntelliMix P300 or ANIUSB-MATRIX.

FITS YOUR ROOM DESIGN

Sleek linear form factor allows for placement virtually anywhere — on the ceiling or wall, around a display, or recessed into the table.

Choose white, black, or aluminum finish. Wall mounting bracket included; other mounting options available.

AVAILABLE MODELS

MXA710-2FT	Linear Array Microphone, 2 foot / 60 cm (aluminum, black, white)	MXA710-4FT	Linear Array Microphone, 4 foot / 120 cm (aluminum, black, white)
------------	------------------------------------------------------------------	------------	-------------------------------------------------------------------

ACCESSORIES

MXA-MUTE Network Mute Button	Touch-sensitive mute button with programmable switch and LED can control one or multiple MXA microphones or DSP units
A710-TB Tile Bridge Ceiling and Suspension Mount Kit	Mounts MXA710 directly to ceiling tiles or suspended from ceiling grids; use one for MXA710-2FT or two for MXA710-4FT
A710-FM Flush Mount	Mounts MXA710 flush within a table, wall or hard ceiling surface
A710-DS Desk Stand	Mounts MXA710 to desk, credenza, or table
A710-MSA Mic Stand Adapter	Mounts MXA710 to any microphone stand in horizontal or vertical orientation

TABLE ARRAY MICROPHONE

TABLE ARRAY MICROPHONE



+ MXA310 TABLE ARRAY MICROPHONE

PREMIUM SOUND WITHIN YOUR REACH.

The MXA310 is the ideal solution when great sound needs to be close at hand. Steerable Coverage™ technology allows up to four separate polar patterns to be easily adjusted to capture multiple talkers around the table. A unique toroid polar pattern rejects overhead noise while picking up talkers all around the table. Built-in Shure DSP utilities optimize voice quality, integrated mute buttons place controls within easy reach.

COVERAGE WHERE YOU WANT IT

Steerable Coverage technology allows you to configure 4 polar patterns to capture talkers around the table.

Unique toroid pattern picks up a 360-degree circle but rejects sound from overhead noise.

NATURAL SOUND

Integrated automix output improves clarity by activating only mics being addressed.

Per-channel parametric EQ reduces noise pickup in rooms with poor acoustics.

FITS YOUR ROOM DESIGN

Programmable touch-sensitive mute buttons can control one mic, all mics, or external devices.

Discreet design with side or bottom cable exit installs on top of table or flush-mounted.



AVAILABLE MODELS

MXA310AL	Table Array Microphone (aluminum)
MXA310B	Table Array Microphone (black)
MXA310W	Table Array Microphone (white)

ACCESSORIES

A310-FM	Flush Mount
---------	-------------



SOFTWARE

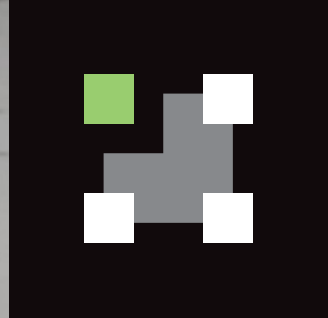
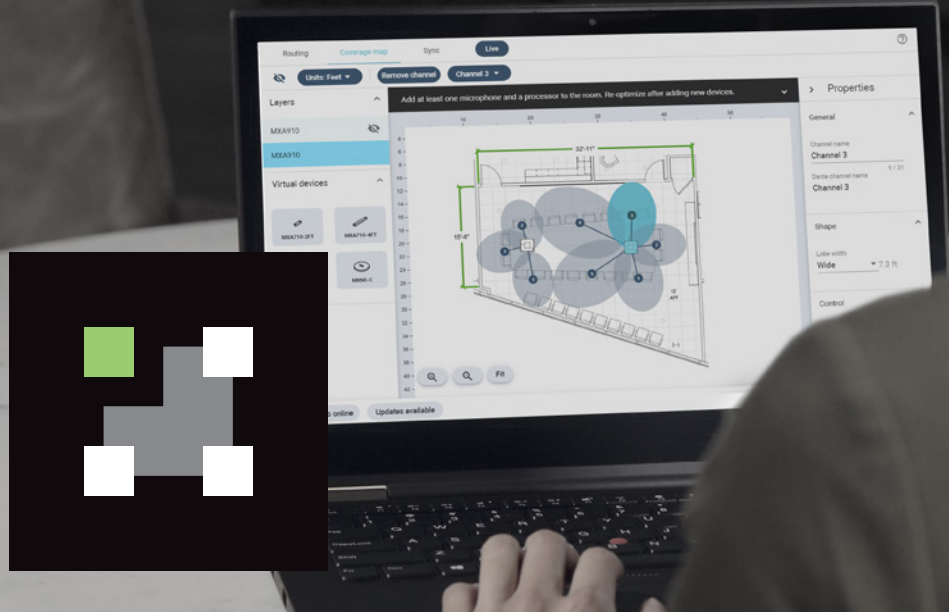

+ DESIGNER SYSTEM CONFIGURATION SOFTWARE

PLAN AMAZING AUDIO.

Simply set-up your Shure Audio Ecosystem with this free software. Deploy more rooms in less time enabling you with more efficiency and consistency. Design projects online and offline.



PRE-CONFIGURED SETTINGS

Configure the Shure Audio Ecosystem for conferencing



STEP AND REPEAT

Create templates based on common floor plans.



PASS IT ON

Room configurations can be saved and shared with colleagues.



SINGLE HUB

Firmware updating and Dante™ audio routing.

SOFTWARE

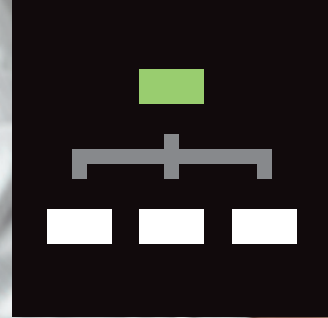

+ SYSTEMON® AUDIO ASSET MANAGEMENT SOFTWARE

CONQUER COMPLEXITY AND SCALE.

You can't be everywhere at once but everywhere can be with you. Update and monitor your Shure Audio Ecosystem remotely. From managing inventory and battery health in real-time and troubleshoot on the go.

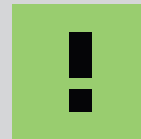

PEACE OF MIND

Stay one step ahead with text and email alerts for potential issues before they happen.



TIME SAVING

Maximize control of your organization's audio and update firmware on the go.

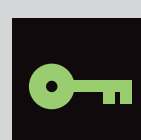

SECURE SYSTEM

Customize access and permissions for a tailored user experience

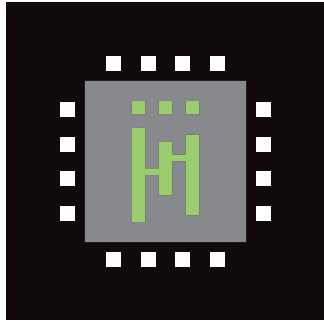

+ INTELLIMIX ROOM®

AV THAT SPEAKS IT.

IntelliMix® Room, the first audio processing software fully optimized for Shure conferencing microphones. Simply download and deploy to in-room Windows 10 devices, and bring conferencing into the future. No custom setups or special hardware needed to enjoy crystal-clear audio on all video conference calls.

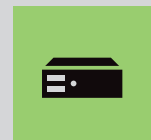

THE HARDWARE'S ALREADY THERE.

IntelliMix® Room effectively turns the in-room PC into a Shure device. All configuration is managed in our Designer software and replicable through easy-to-use templates.



DANTE ONBOARD.

Once the PC has IntelliMix Room onboard, it has Dante audio networking too. No other software license is needed to route audio to or from that PC.

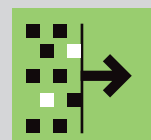

ELIMINATE DISTRACTING SOUNDS.

Version 3.1 includes the AI Denoiser audio processor - a powerful algorithm that eliminates the random noises that disrupt meetings, with virtually no audible effect on the speech.



NO COMPLICATED AUDIO ROUTING.

IntelliMix Room installs with its own audio driver. Once selected from the Audio Device dropdown in the Soft Codec of choice, the client is ready to talk.

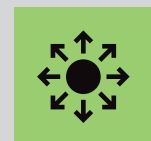

ENTERPRISE-WIDE LICENSING.

A centrally managed license lets clients easily and effectively deploy the software through their global corporate network.



PUT A STOP TO EAVESDROP.

All connected Shure devices feature Shure Audio Encryption, so the only ones to hear it are the ones on the call.



MAKE SIMPLE THE NEW STANDARD.

Now all it takes to optimize audio is award-winning Shure MXA mics and a PC running a conferencing application and IntelliMix® Room.

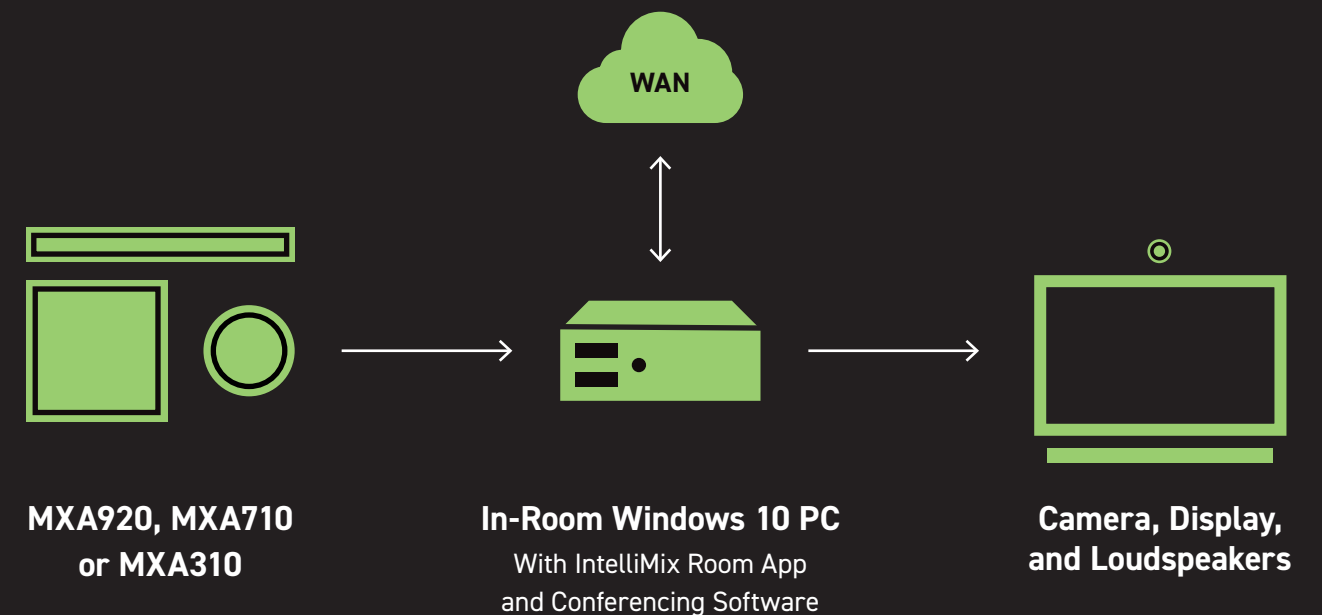

APPLICATION FLEXIBILITY

Match single or multiple arrays to the AV conferencing needs of rooms of any size, configuration or activity: formal presentations, intimate discussions, distance learning or collaborative work.

+ TABLE ARRAY COVERAGE MAPS

+ Small Rectangular Table
1 Table Array

Profile
6 Chairs
1 Rectangular Table

1 Bi-Directional Pattern
2 Cardioid Patterns

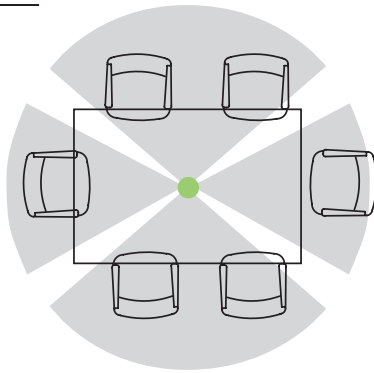

+ Medium Round Table
1 Table Array

Profile
9 Chairs
1 Round Table

1 Toroid Pattern

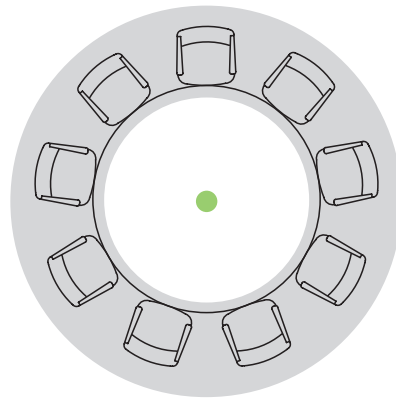

+ Square Table
1 Table Array

Profile
8 Chairs
1 Square Table

4 Supercardioid Patterns

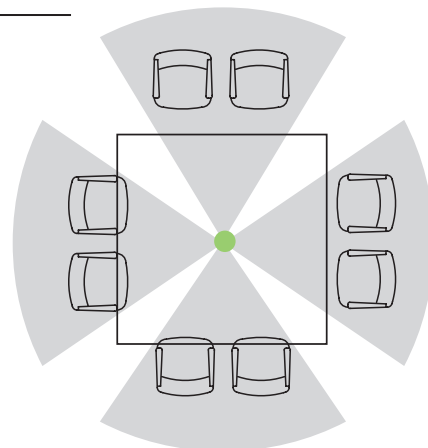

+ Rectangular Table
1 Table Array

Profile
7 Chairs
1 Rectangular Table

1 Supercardioid Pattern
2 Cardioid Patterns

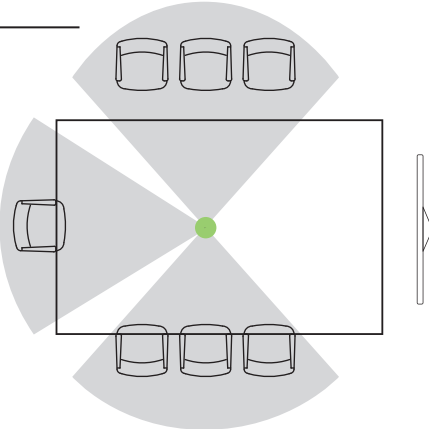

+ LINEAR ARRAY COVERAGE MAPS

+ Small Rectangular Table
MXA710-2FT
Coverage Distance: Up to 16 ft
Channels used: 3 of 4
Mic Coverage: Default

Horizontal Wall Installation

Profile
9 Chairs
1 Rectangular Table

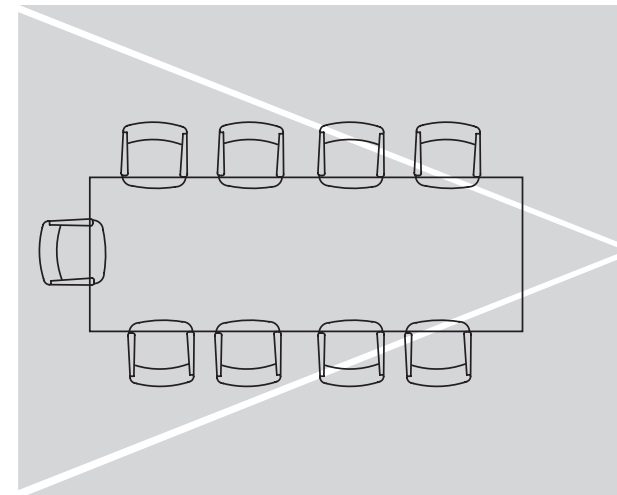

+ Large Rectangular Table
MXA710-4FT
Coverage Distance: Up to 20 ft
Channels used: 5 of 8
Mic Coverage: Custom/Optimized

Horizontal Wall Installation

Profile
13 Chairs
1 Rectangular Table

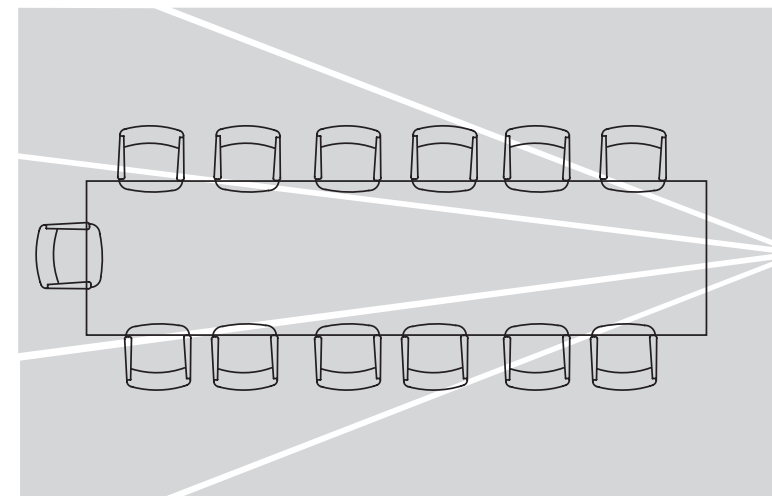

+ CEILING ARRAY COVERAGE MAPS *

+ Large Conference Room 2 Ceiling Arrays

Profile
28 Chairs
1 Rectangular Table

2 Coverage Areas

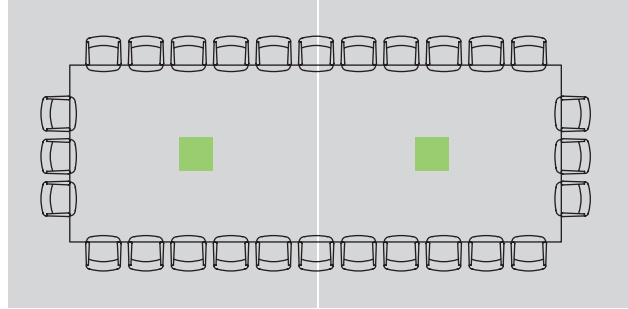

+ Medium Conference Room 1 Ceiling Array

Profile
14 Chairs
1 Rectangular Table

1 Coverage Area

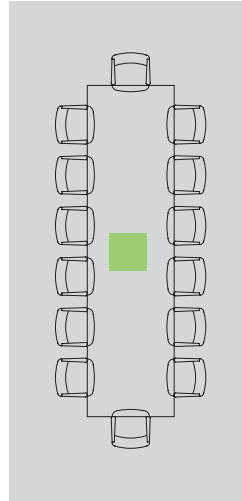

+ Videoconference Room 1 Ceiling Array

Profile
21 Chairs
3 Rectangular Tables

3 Coverage Areas

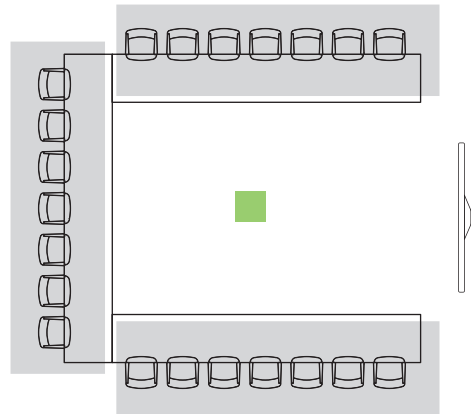

+ Classroom / Presentation Room 1 Ceiling Array

Profile
16 Chairs
4 Rectangular Tables

5 Coverage Areas

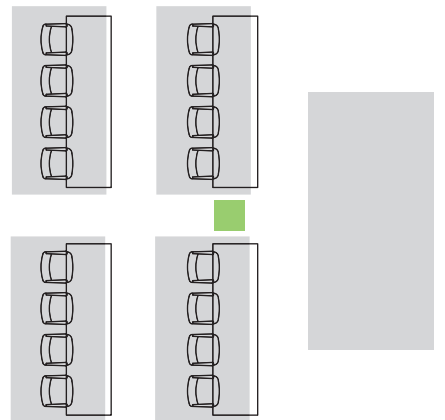

* Coverage Capabilities

Installed at a height of 3 meters (ten feet), Ceiling Arrays capture audio from seated participants to a recommended area of 9 meters (30 feet) in diameter, meeting the STIPA "A" intelligibility rating.

** Note:

Ceiling Arrays are capable of picking up participants beyond 9 meters (30 feet).

** Room conditions:

RT60 (reverb time)
= 500 ms @ 1kHz, weighted room noise
= 40dB SPL(A). IEC-60268-16.

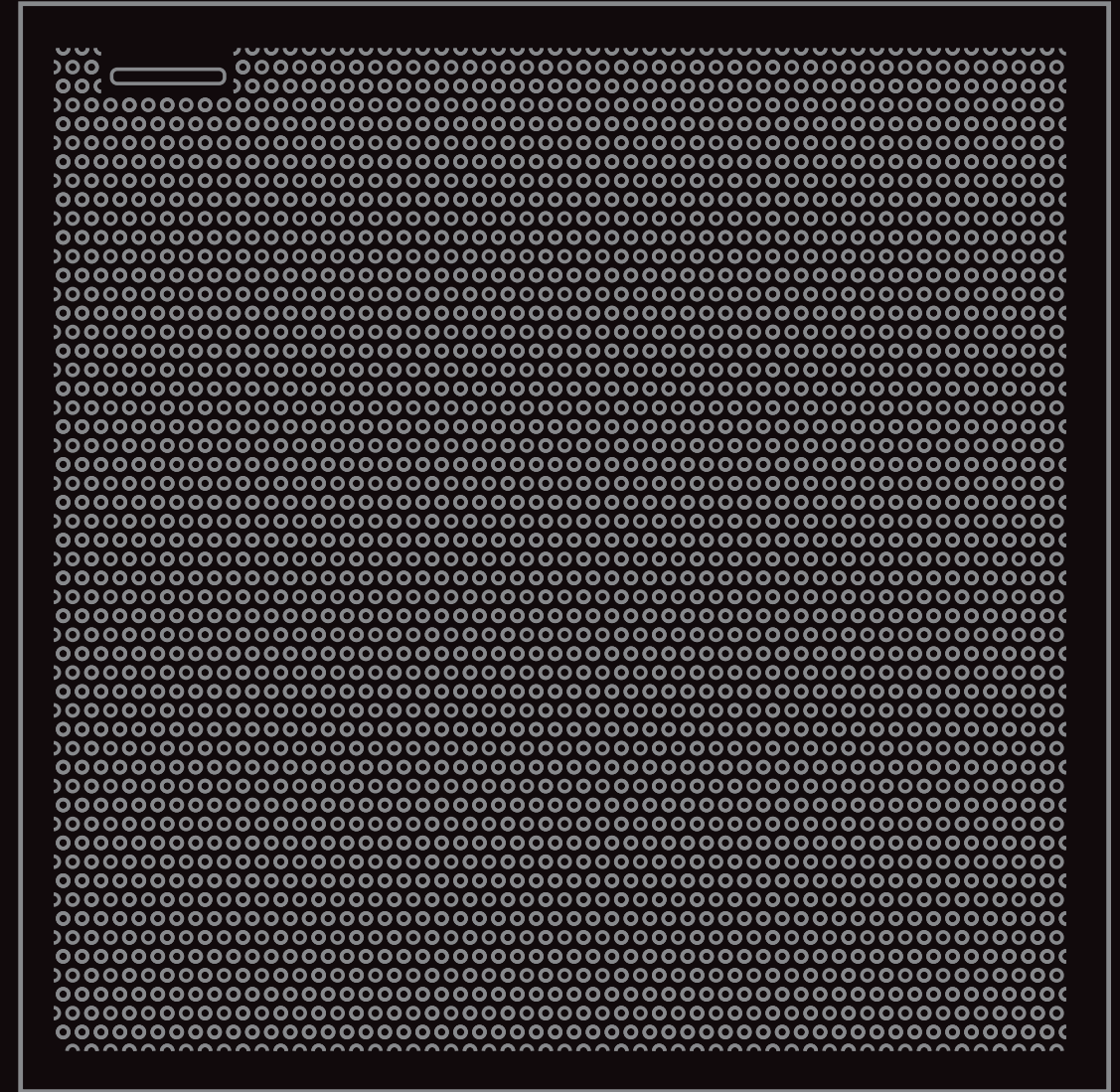

BETTER TOGETHER.

Shure Networked Audio Processors and Interfaces quickly and easily integrate with Microflex Advance providing high-quality audio conferencing solution with extremely intelligible meeting sound.

+ INTELLIMIX® P300 AUDIO CONFERENCING PROCESSOR

The IntelliMix P300 Audio Conferencing Processor offers DSP algorithms optimized for AV conferencing applications with Microflex Advance microphones. Featuring acoustic echo cancellation, noise reduction and automatic gain control for up to 8 Dante channels, the P300-IMX helps to ensure echo- and noise-free conference room audio that facilitates communication and collaboration. Easy to install and configure using Designer System Configuration software, the P300 provides Dante, analog, USB and mobile connectivity options that make joining room systems and collaborating with laptops and mobile devices easier than ever.

- Features**
- IntelliMix® DSP
 - 10 Dante input channels, 8 output channels
 - 2 analog audio inputs / 2 outputs
 - USB 2.0
 - 15 x 12 Matrix Mixer
 - 3.5mm Mobile input (1/8")
 - Easy deployment with Designer System Configuration software
 - Single Ethernet connectivity
 - 10 configuration presets
 - Third-party control system compatible
 - Dante Domain Manager ready
 - Power over Ethernet plus (PoE+)
 - 8 Channels of Acoustic Echo Cancellation

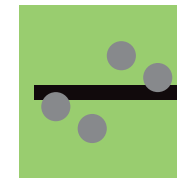

AUDIO PERFORMANCE

Enhanced meeting room audio for natural communication and better interaction in AV conferences with remote team members.



INTUITIVE CONNECTIONS

Industry-first mute sync functionality when MXA microphones are connected to the P300 for better operation with leading third-party software codecs.



SIMPLICITY

Pre-defined templates for system configuration reduce programming time, and allow installation within seconds.

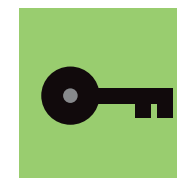

SHURE AUDIO ENCRYPTION

When using Microflex Advance together with the IntelliMix P300 Audio Conferencing Processor and selected Shure Audio Network Interfaces, Shure Audio Encryption with AES-256 encryption technology can help protect confidential content.

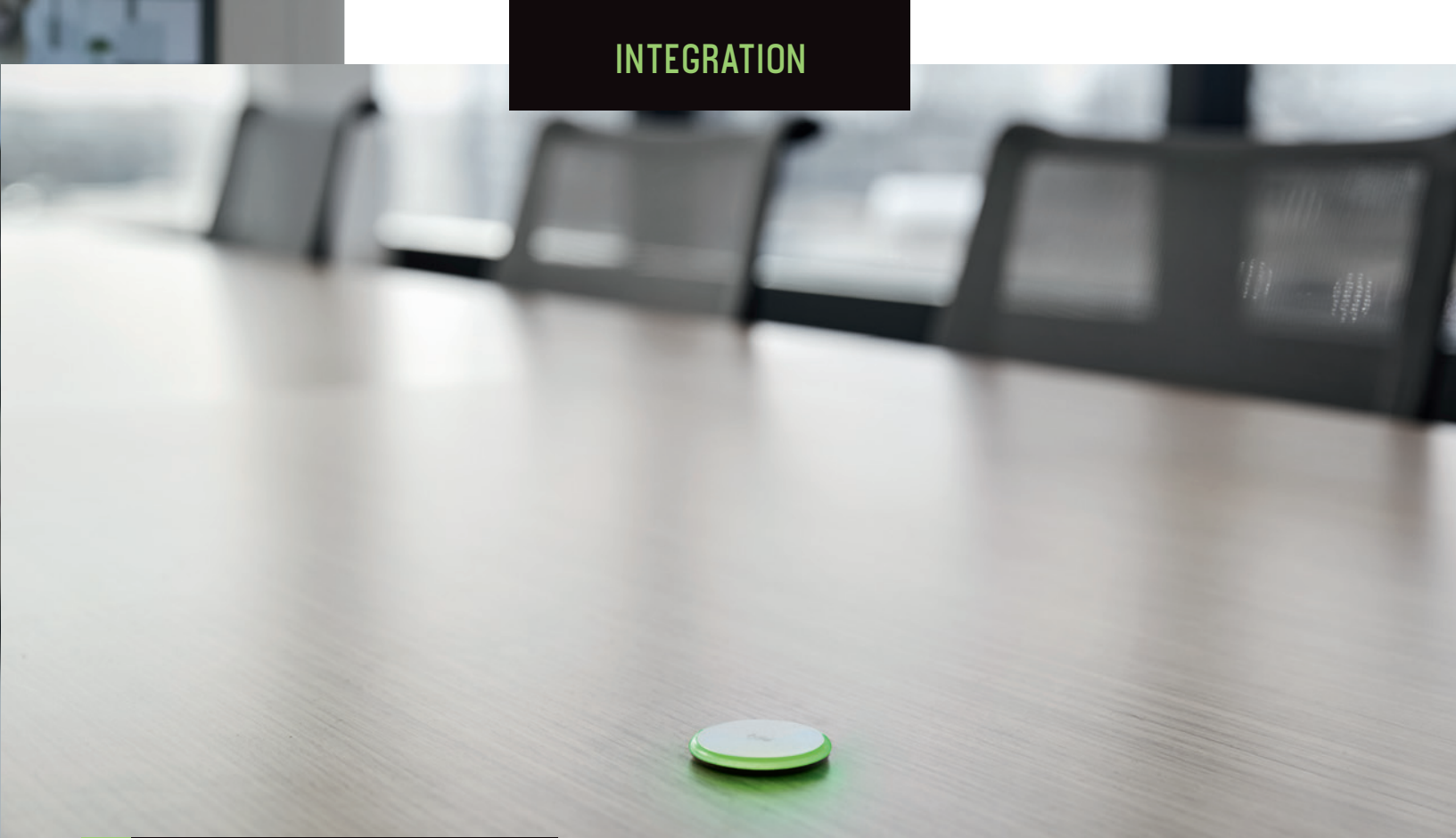

+ ANIUSB-MATRIX USB AUDIO NETWORK INTERFACE WITH MATRIX MIXING

The ANIUSB-MATRIX Audio Network Interface provides a versatile hub for collaboration in small to medium-size meeting rooms, suitable for both room video conference systems and soft codec solutions. The device presents a budget-friendly companion to Microflex Advance microphones, for AV conferencing applications that leverage the integrated processing functionality of existing video codecs in the room.

Features

- 4 Dante audio inputs / 2 outputs
- 1 analog audio input / 1 output
- USB 2.0
- 6 X 4 Matrix Mixer
- Per channel Equalizer, Mute, Limiter, Gain
- Easy deployment with Designer System Configuration software
- Single Ethernet connectivity
- 10 configuration presets
- Dante Domain Manager ready
- Third-party control system compatible
- Power over Ethernet (PoE)



+ MXA NETWORK MUTE BUTTON

The MXA Network Mute Button is a configurable PoE-powered mute button accessory designed for Shure networked audio products, including Microflex® Advance™ Array Microphones as well as the IntelliMix® P300 and IntelliMix Room DSPs, and ANIUSB-MATRIX. One or many of the low-profile touch sensitive mute buttons can be configured to mute one or multiple microphones, depending on user needs or room configurations.

Features

- Designer System Configuration software for easy setup and configuration
- SystemOn™ Asset Management for remote management & troubleshooting
- PoE powered
- Compatible with third party control systems via programmable control strings
- LED status ring with configurable colors and brightness
- Configurable as toggle, push to talk and push to mute functionality
- IP1X rated
- Easy table installation in 1" (25mm) or 7/8" (22mm) holes



INSTALLATION



SHURE

INSTALLATION SOLUTIONS

MXA920 Ceiling Array Microphones are designed for suspension, pole and flush mounting in metric or imperial formats. The sleek, linear form factor of the MXA710 allows for placement virtually anywhere in a meeting space, including on a wall, around a display, ceiling, or into a conference room table. MXA310 Table Array Microphones feature through-the-table mounting kits. The A310-FM mounting accessory also allows flush mounting in a table.



INSTALLATION

MXA920 CEILING ARRAY MOUNTING OPTIONS

Integrated Vibration Isolation

Prevents transmission of mechanical noise through the microphone.

Plenum-Rated

UL 2043 suitable for air handling spaces and plenum compliant (-S models only)

Dust Protection

IEC 60529 IP5X Dust Protected



+ CEILING GRID

MXA910W-US installation shown



+ SUSPENSION MOUNT

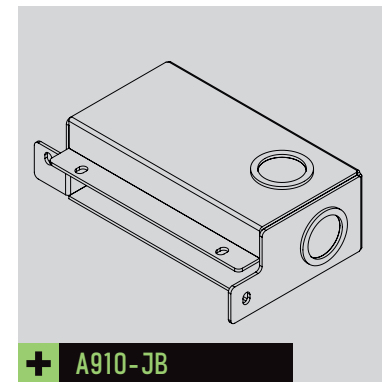

+ A910-JB

Allows the Ethernet cable connected to the array to be installed inside flex conduit.



+ VESA POLE MOUNT



+ HARD CEILING

Requires A910-HCM accessory

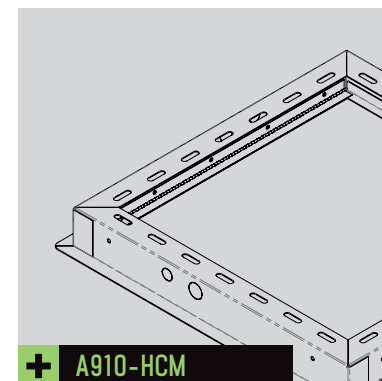

+ A910-HCM

Hard Ceiling Mount
Can be pre-installed in the ceiling and the MXA910 installed later using the access door. Provides knockouts for conduit connections.



+ VESA POLE MOUNT



+ SUSPENSION MOUNT

MXA310 TABLE ARRAY MOUNTING OPTIONS

+ TABLE ARRAY MOUNTING KIT (INCLUDED)

Cable management solutions for on-the-table or through-the-table applications; includes mounting tube/wingnut.

MXA310 retrofits existing Shure table mounted MX395, MX396, MX392 boundary microphones.



+ A310-FM FLUSH MOUNT (OPTIONAL)

Allows MXA310 Table Array to be mounted flush in the table; includes rubber isolation to prevent mechanical vibrations.

Available in black and aluminum finishes; paintable to match table surface.

MXA710 LINEAR ARRAY MOUNTING OPTIONS



+ SUSPENSION MOUNT



+ BELOW DISPLAY WITH THIRD-PARTY MOUNT

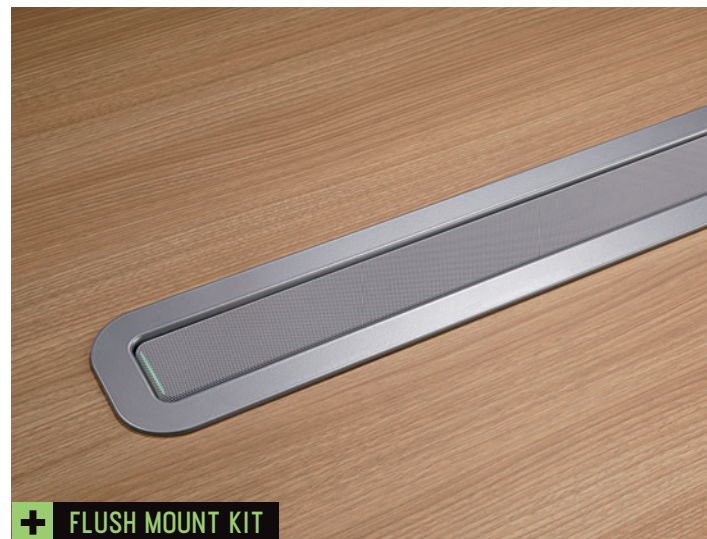

+ FLUSH MOUNT KIT



+ WITH A710-DS DESKTOP STAND

EXPRESSIVE FINISHES

Ceiling and Table Array microphones are available in black, white and aluminum finishes to match room aesthetics or the finishes of other AV system components. The Ceiling Array microphone can also be custom-painted to fit your environment.

